



Model Number

LC10-1-D 230 VAC

Loop detector
230 V AC

Features

- Sensor system for vehicle detection
- Complete control interface for inductive loops laid beneath the surface
- Reliable detection with long service life
- Various operating modes available
- Boost function for increasing sensitivity
- Test function
- Version with 1 loop channel

Product information

Together with the inductive loops laid beneath the surface, the LC series loop detectors form a universal sensor system for detecting vehicles. People are not detected. Vehicles that enter the inductive loop change the resonant frequency. This frequency change is measured and analyzed by the microprocessor in the LC10 loop detector. The analysis is automatically and periodically adjusted to the respective loop, ensuring that any changes in the loop inductance caused by temperature, humidity or component age are automatically compensated for.

Dimensions

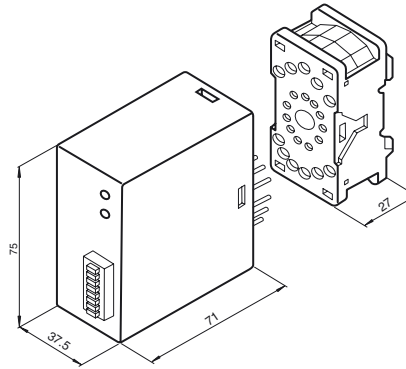

Electrical connection

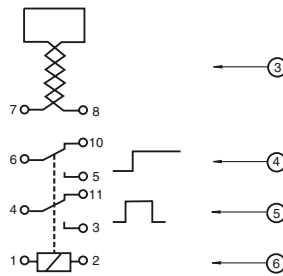

Number	Explanation	Connector terminals
3	Loop connection	7/8
4	Signal output, maintained contact	5/6 = NO 6/10 = NC
5	Signal output, pulse contact	3/4 = NO 4/11 = NC
6	Operating voltage	1/2

Indicators/operating means

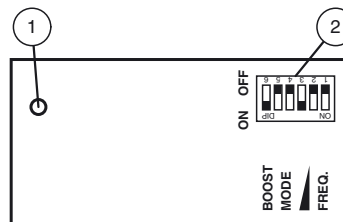

1	LED display
2	DIP switch

Release date: 2013-07-08 14:27 Date of issue: 2013-07-08 190924_eng.xml

Refer to "General Notes Relating to Pepperl+Fuchs Product Information".

Pepperl+Fuchs Group
www.pepperl-fuchs.com

USA: +1 330 486 0001
fa-info@us.pepperl-fuchs.com

Germany: +49 621 776 4411
fa-info@de.pepperl-fuchs.com

Singapore: +65 6779 9091
fa-info@sg.pepperl-fuchs.com

Technical data

General specifications

Marking	CE
Operating mode	Pulsed and continuous signal

Functional safety related parameters

MTTF _d	306 a
Mission Time (T _M)	20 a

Indicators/operating means

Controls	DIP-switch
Switching state	LED

Electrical specifications

Operating voltage	U _B	230 V AC (galvanically isolated from loop)
Ripple		-15 %/+10 %
Power consumption	P ₀	1.6 VA
Calibration time		2 s
Loop inductivity		100 ... 1000 μH
Loop frequency		20 ... 120 kHz

Input

Number of channels	1
--------------------	---

Output

Output type	relay
Switching voltage	250 V AC
Switching current	6 A
Pulse length	period or 800 ms Pulse
Response time	100 ms

Ambient conditions

Ambient temperature	-20 ... 70 °C (-4 ... 158 °F)
Storage temperature	-40 ... 70 °C (-40 ... 158 °F)

Mechanical specifications

Protection degree	IP30
Connection	Plug socket ; 11-pin Terminal connection ≤ 1.5 mm ²

Typical applications

- Selective vehicle detection
- Opening impulse sensor for automatic gates and barrier systems
- Presence checks for vehicles
- Controlling traffic light and vehicle detection systems
- Ticket detection in parking garages
- Managing tasks in automatic conveyor systems

Detection area

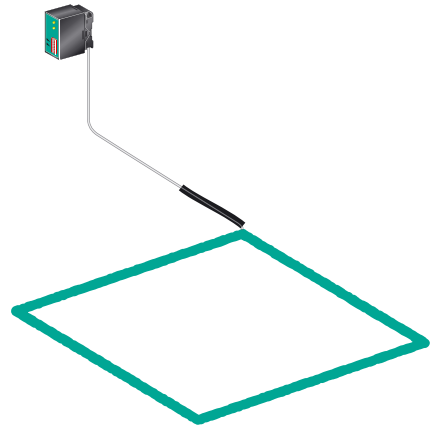

Curves/Diagrams

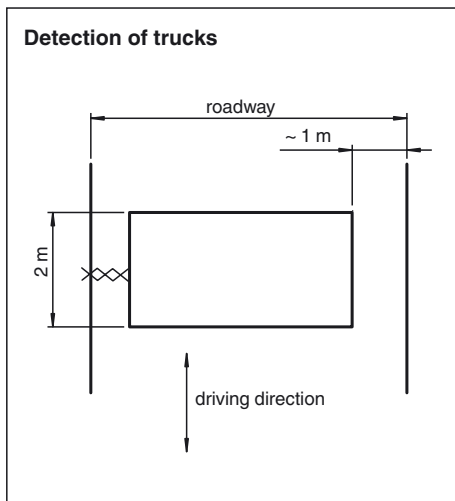
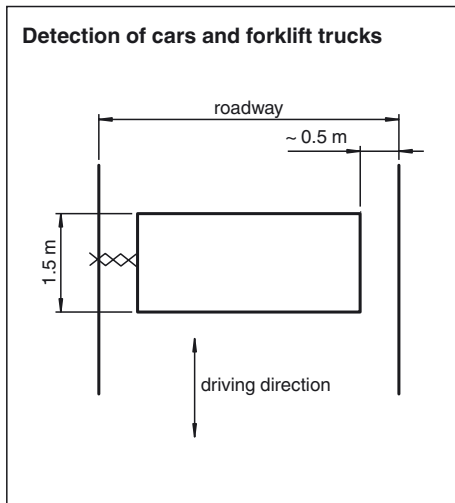

Release date: 2013-07-08 14:27 Date of issue: 2013-07-08 190924_eng.xml

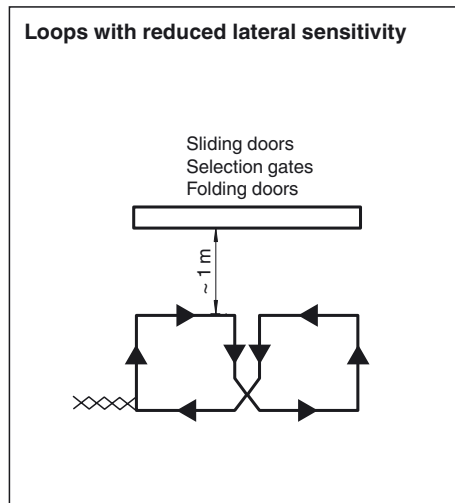
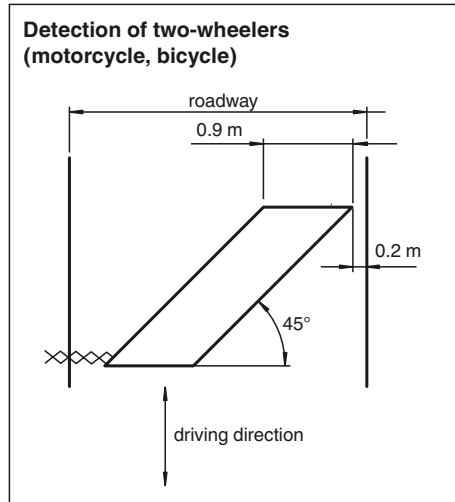

Functional principle

The loop detectors are control units that are fully functional without the need for any other auxiliary equipment once the power supply and an inductive loop have been connected. The inductive loop laid below the surface forms the inductor of a high-frequency oscillating circuit. The metal parts of a vehicle that enters or is located in this wired loop cause the frequency of the oscillation circuit to change. This frequency change is analyzed by the loop detector, and the outputs, which are zero-potential relay contacts, can switch. The switching outputs are relay contacts with a high switching power that can directly control contactors, valves and alternating current motors. The dimensions of the detection area can be adjusted by changing the size and shape of the inductive loops.

Settings:

Sensitivity:

The response sensitivity of the loop detector can be set in three stages by switches 3 and 4.

Switch 3	Switch 4	Sensitivity
OFF	ON	low
ON	OFF	medium
ON	ON	high

In the switch position "OFF", "OFF" the loop evaluation is switched off.

Frequency switches:

The loop frequency can be set in four stages using the switches 1 and 2.

Switch 1	Switch 2	Frequency
OFF	OFF	Basic frequency f
ON	OFF	f - 10 %

Release date: 2013-07-08 14:27 Date of issue: 2013-07-08 190924_eng.xml

Refer to "General Notes Relating to Pepperl+Fuchs Product Information".

Switch 1	Switch 2	Frequency
OFF	ON	f - 15 %
ON	ON	f - 20 %

After actuation of the frequency switches 1 and 2 the loop must be readjusted with switches 3 and 4 set to "OFF", "OFF".

Operating mode switches:

The following operating modes can be set with switches 5 and 6:

Switch 5	Switch 6	Result
OFF	-	Pulse (0.8 s) when loop is allocated
ON	-	Pulse (0.8 s) when loop is abandoned
-	ON	Increased sensitivity (Boost)

The increased sensitivity (Boost) is used for the detection of vehicles with high body assemblies, e.g. HGVs.

Automatic adjustment:

When the operating voltage is applied to the device automatic adjustment with the loop takes place. The output relays are switched in the switch position "Loop not allocated". The adjustment takes 2 s, the device is then ready for operation.

Automatic adjustment also takes place when both sensitivity switches 3 and 4 are set to "OFF" and then set to another switch position.

Indications:

LED signals the allocation state of the loop (Loop allocated = LED On). A fault in the loop due to a short-circuit or lead breakage and loop inductance outside the permissible range is indicated by flashing of LED.

Test function:

The loop detector is provided with an integrated test function, which enables the loop frequency and sensitivity to be optimally set without additional devices or instrumentation.

Indication of the recommended sensitivity:

The vehicle must be driven onto the loop. The loop detector measures and stores the frequency change. When switches 3 and 4 are changed over the recommended sensitivity is indicated by flashing of the LED.

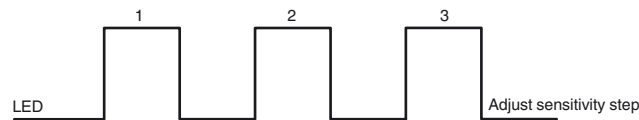

Measurement of the loop frequency:

The loop frequency can be measured via the LED. Set switches 3 and 4 from "OFF" to "ON". The LED indicates the loop frequency via a signal sequence:

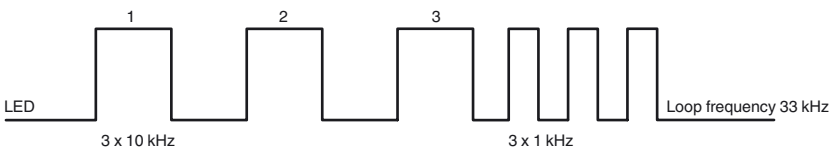

Loop fault:

In the event of lead breakage or short-circuit the LED flashes continuously and the switch contact reverts to the "Loop allocated" state.

Release date: 2013-07-08 14:27 Date of issue: 2013-07-08 190924_eng.xml